

# Nuclear reactions in the Sun and solar neutrinos

- The spies of nuclear reactions in the Sun
- The luminosity constraint
- The pp chain
  - pp neutrinos
  - Be neutrinos
  - B neutrinos
- The CNO cycle
- What can we learn about the Sun from solar neutrino experiments?

# The spies of nuclear reactions in the Sun

- The proof of the occurrence of nuclear reactions is in the detection of reaction products.
- Of these, only neutrinos can escape freely from the production region. Their detection can thus shed light on the energy production mechanism of the Sun.
- By measuring solar neutrino spectra one can learn about properties of the solar interior, in the energy production region which is the innermost and most hidden to other observations.
- One can also learn about neutrino properties

# The luminosity constraint (1)

- The total neutrino flux is immediately derived from the solar constant  $K_o$ :
- If one assumes that Sun is powered by transforming H into He with a heat release  $Q_H$ :



- Due to L conservation, 2 neutrinos must appear on the r.h.s.
- If  $L_e$  also is conserved they must be of electron type:



- Then one has  $2\nu_e$  for each  $Q_H$  of radiated energy, and the total neutrino produced flux is:

$$\Phi_{TOT} = 2 K_o / Q_H$$

## The luminosity constraint (2)

- A more tedious but may be more transparent derivation is the following one
- From measurement of  $K_o$  one deduces the solar luminosity  $L = 4\pi K_o D^2$  where  $D$  is the Sun Earth distance.
- If this energy is produced by nuclear fusion, with each fusion releasing an amount of heat  $Q_H$ , then one derives the fusion rate  $dN_f/dt = L / Q_H = 4\pi K_o D^2 / Q_H$
- Since each fusion provides 2 neutrinos, the neutrino production rate is  $dN_\nu/dt = 2dN_f/dt = 8\pi K_o D^2 / Q_H$
- The neutrino flux is then obtained by  $\Phi_{TOT} = dN_\nu/dt / (4\pi D^2)$  which gives again:

$$\Phi_{TOT} = 2 K_o / Q_H$$

# Heat release in $4p+2e^- \rightarrow {}^4\text{He}+ 2\nu_e$

- The Q value of the reaction

$$Q = 4m_p + 2m_e - m_{{}^4\text{He}} = 26.7 \text{ MeV}$$

is the energy which can be carried by the reaction products.

- Ultimately, this energy is in the form of photons (Heat) and neutrinos which escape from the Sun

$$Q = Q_H + 2\langle E_{\nu} \rangle$$

- where the average energy carried away by neutrinos is  $\langle E_{\nu} \rangle = 0.2 \text{ MeV}$ , so that  $Q_H = 26.3 \text{ MeV}$ . In practice, almost all the energy is carried by photons and little is “wasted” in neutrinos\*\*

- At this point one can easily estimate the total neutrino flux\*\*

$$\Phi_{\text{TOT}} = 2 K_o / Q_H = 6.4 \cdot 10^{10} / \text{cm}^2/\text{s}$$

\*\*Exercise: what is the photon flux from the sun? (photons//cm<sup>2</sup>/s)

\*) Note that the opposite occurs in a collapse supernova, where most of the energy is carried by neutrinos, and photons only account for % of the total emitted energy

# Nuclear reactions in the sun and neutrino energy spectra

- To determine  $\Phi_{\text{tot}}$  we did not use anything about nuclear reactions and/or solar models.
- In fact, fusion of 4 protons into Helium in stars can occur through different (chains of) reactions, depending on the properties of the stellar interior.
  - pp-chains (through its terminations/subchains ppI, ppII, pp3)
  - CNO cycle
  - advanced Hydrogen burning (p-Mg, p-Ne ....)
- Different chains produce different neutrino energy spectra.
- Measurements of neutrino spectra can thus shed light on the way nuclear reactions proceed in the Sun and thus on the physical conditions of the stellar interior where reactions occur.
- The next slide shows the full pp-chain...

# The pp chain

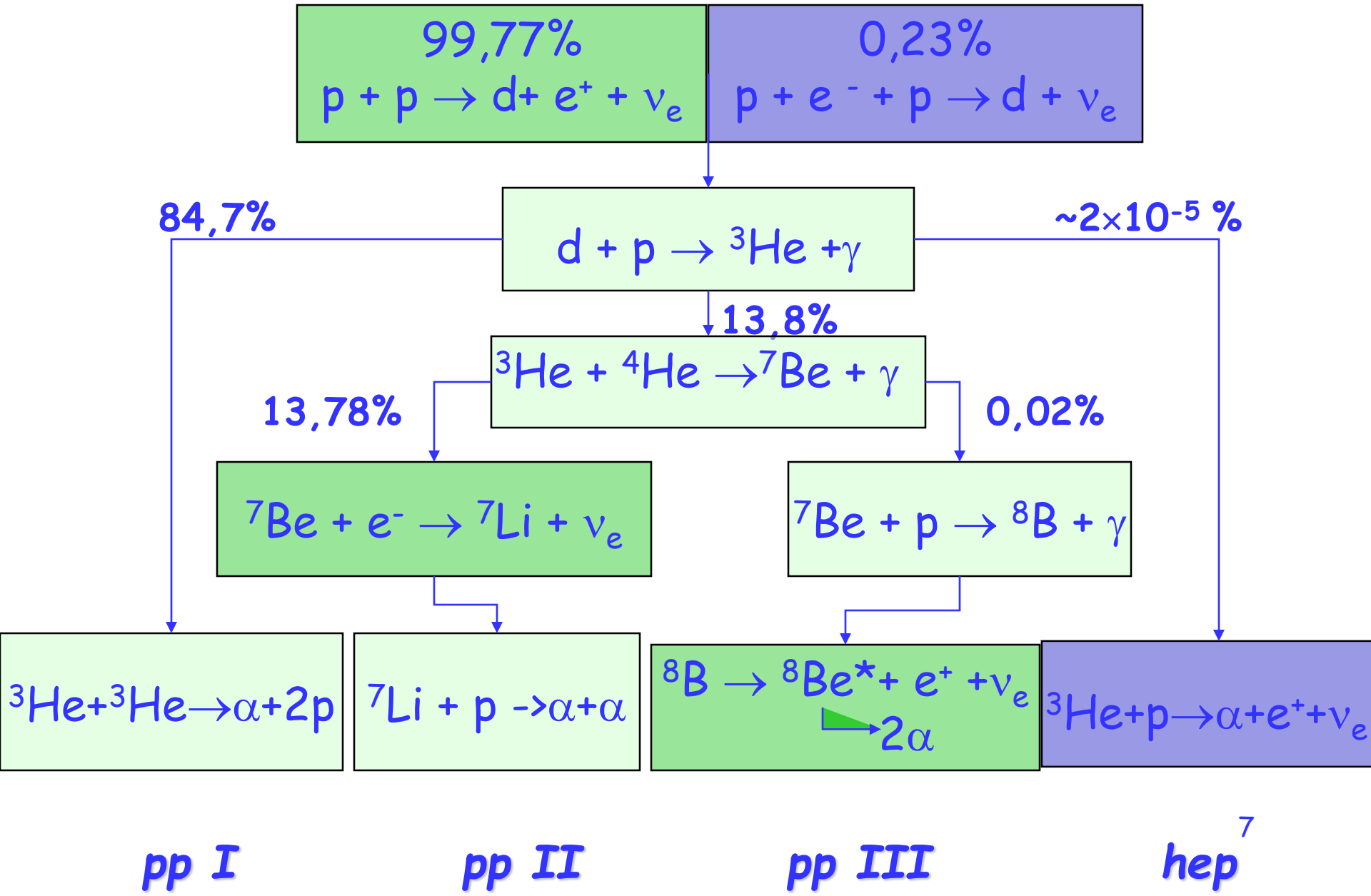

# The pp-I chain

- Reactions involving nuclei with the smallest charges are favoured, due to smaller Coulomb barrier. This is the reason why in the Sun we believe that pp-I is the dominant energy production mechanism, accounting for some 90% of the total energy production.
- It proceeds along the following steps

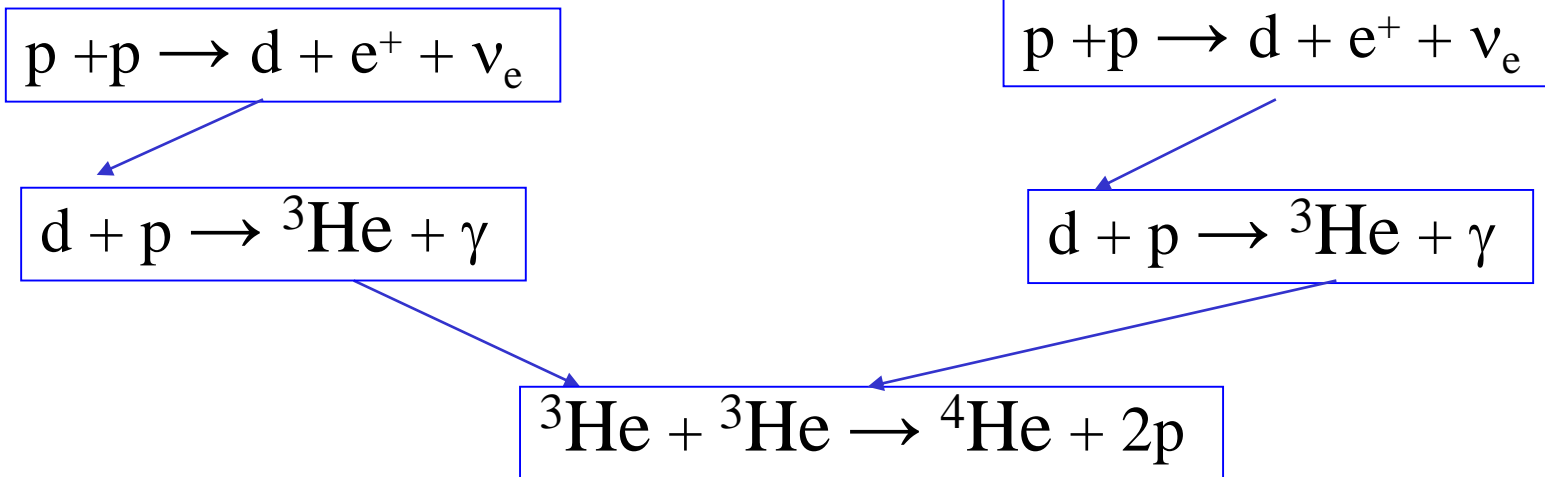

- Each  $e^+$  will annihilate against  $e^-$  in the plasma
- The full result is





## Remarks on pp-I chain : pp neutrinos

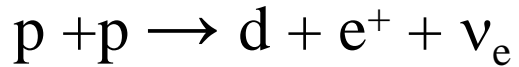

- Note that the first step is a weak interaction process,
- It transforms the  $p$ 's into  $n$ 's necessary to form  ${}^4\text{He}$ ; this is different from BBN, where free neutrons were available.
- The produced neutrinos (called pp- $\nu$ ) have a continuous spectrum, with  $E_{\text{max}}=0.4 \text{ MeV}$  and  $\langle E \rangle=0.2 \text{ MeV}$

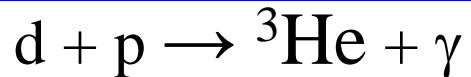

- This is an e.m process, which destroys  $d$ . This is generally the fate of  $d$  in stars and the reason why it is rare. It is formed by weak process where Hydrogen is present, and is destroyed by an e. m. process which requires Hydrogen

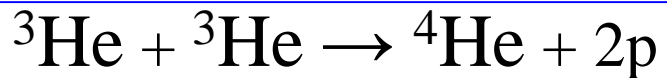

- It is a strong interaction process, which completes the chain.

# pp neutrinos

- Energy spectra and production region is shown for pp neutrinos.
- pp neutrinos are :
  - the dominant component in number
  - the component with smallest energy
  - The component which is produced in a relatively extended area of the Sun, concentrated however within 1/3 of the solar radius and with a maximum at 1/10 of  $R_{\odot}$

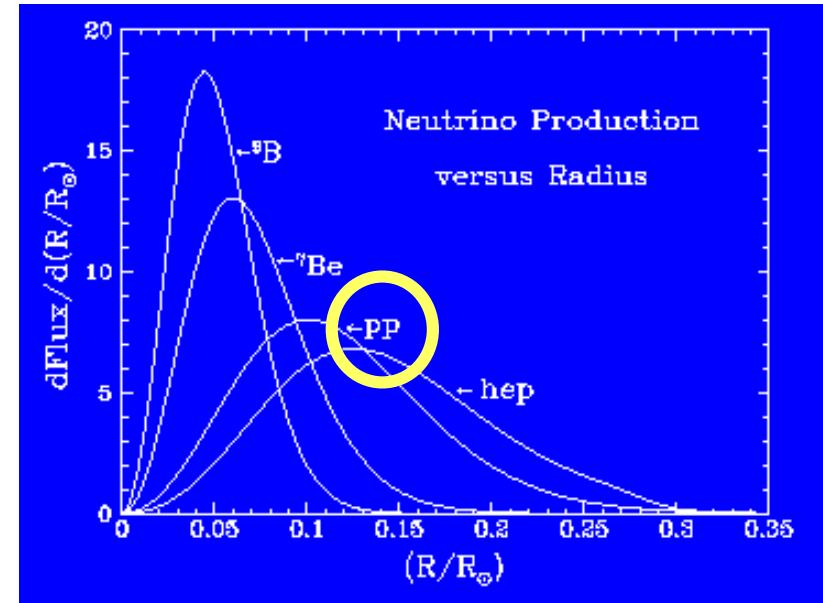
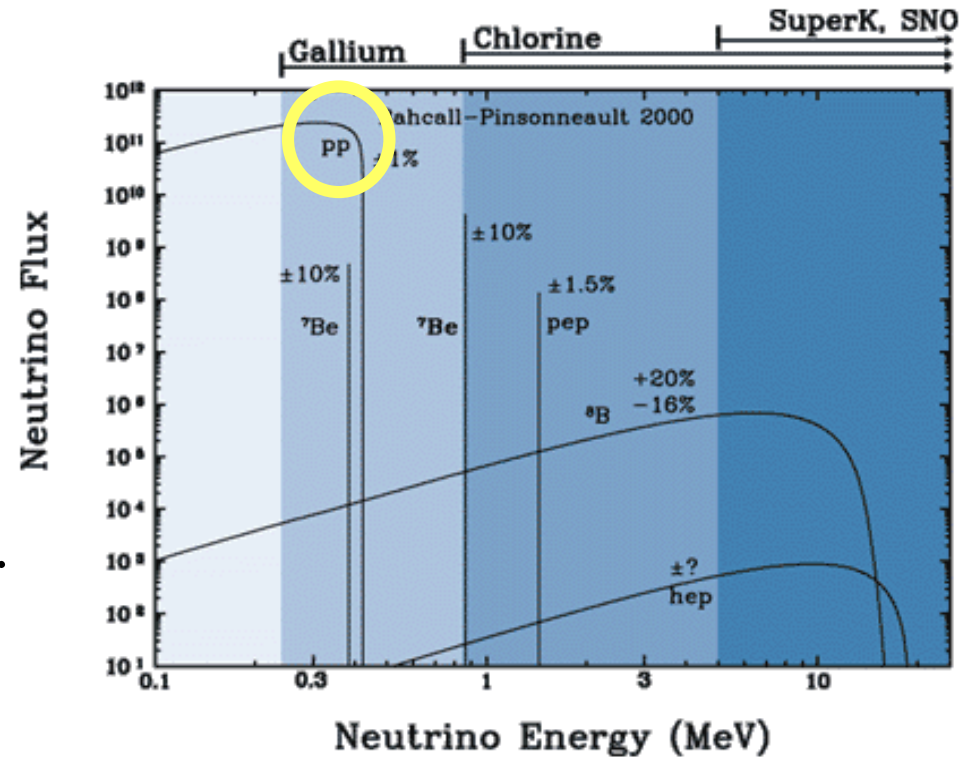

# Equilibrium conditions and nuclear abundances

- In a large fraction of the energy production region the chain is equilibrated, i.e. at any point, the production rate of the intermediate products is equilibrated by their destruction rate.
- This can be used to derive the local densities of the different nuclei in terms of that of hydrogen,  $n_1$ \*
- For d, by requiring that the formation rate ( $1/2 n_1^2 \langle \sigma v \rangle_{11}$ ) equals the destruction rate ( $n_1 n_2 \langle \sigma v \rangle_{12}$ ), one finds  $n_2 = 1/2 n_1 \langle \sigma v \rangle_{11} / \langle \sigma v \rangle_{12}$ , and for the mass abundances:  $a(\text{D})/a(\text{H}) = \langle \sigma v \rangle_{11} / \langle \sigma v \rangle_{12}$
- Deuterium abundance is very low with respect to that of Hydrogen as it involves the ratio of a weak to an e.m. process.
- Similarly, one can equate  $^3\text{He}$  destruction rate ( $2 \times 1/2 n_3^2 \langle \sigma v \rangle_{33}$ ) to its formation rate, obtaining:  $a(^3\text{He})/a(\text{H}) = 3/\sqrt{2} (\langle \sigma v \rangle_{11} / \langle \sigma v \rangle_{33})^{1/2}$
- Also  $^3\text{He}$  is very rare, for the same reasons as for deuterium
- Note that the ratio of abundances are determined by ratios of nuclear reaction rates, i.e. depend on the S-factors and temperature .

\*)  $n_i$  is the number density of the nuclides with mass number  $i$  and  $\langle \sigma v \rangle_{ij}$  is the collision<sup>11</sup> rate between nuclei with mass numbers  $i$  and  $j$ .

# The pp-II chain and Beryllium neutrinos

- Indeed,  ${}^3\text{He}$  can be destroyed also in collisions with  ${}^4\text{He}$ ,

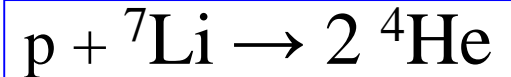
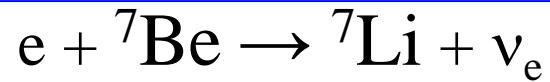
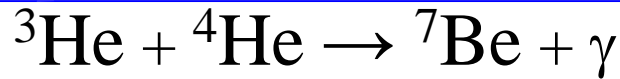
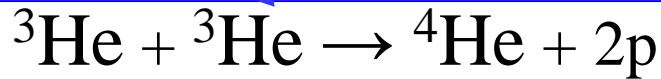

- Collisions with  ${}^4\text{He}$  are less likely, since an e.m process is involved and more massive particles are involved in the tunneling.
- A (bare) nucleus of  ${}^7\text{Be}$ , in vacuum is stable\* but in the plasma an electron can be captured, with emission of a monochromatic Be-neutrino\*\* with  $E=0.8$  MeV.
- Be neutrinos are 10% with respect to pp neutrinos.

\*) Exercise: One has:  $m({}^7\text{Be}) - m({}^7\text{Li}) = 0.3$  MeV. Prove that  $\beta^+$  is forbidden whereas EC is allowed by energy conservation

\*\*\*) In fact it is dichromatic, since also an excited state of  ${}^7\text{Li}$  can also be produced, with 10% probability.

## Be neutrinos

- Shape and production region are shown in the figures
- Be neutrinos are:
  - the second source in intensity, after pp
  - They are “intermediate energy neutrinos”, in that their energy is in between that of pp and B.
  - They are produced in a more central region, where reaction with  $^4\text{He}$  is more likely due to higher temperature.

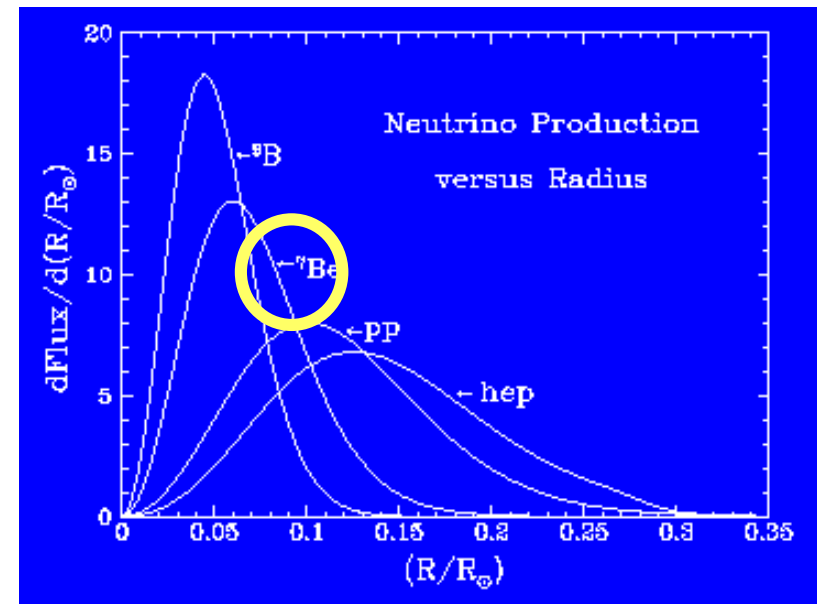
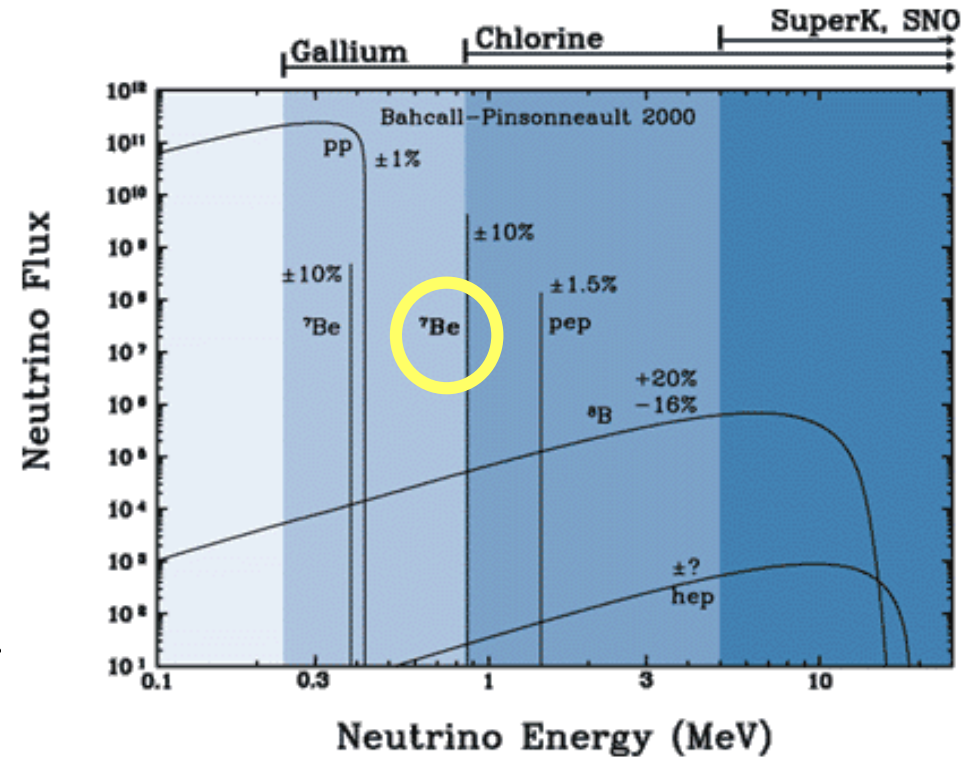

# The pp-III chain and Boron neutrinos

- Indeed,  ${}^7\text{Be}$  can be destroyed also in collisions with protons, i.e. proton capture instead of electron capture,

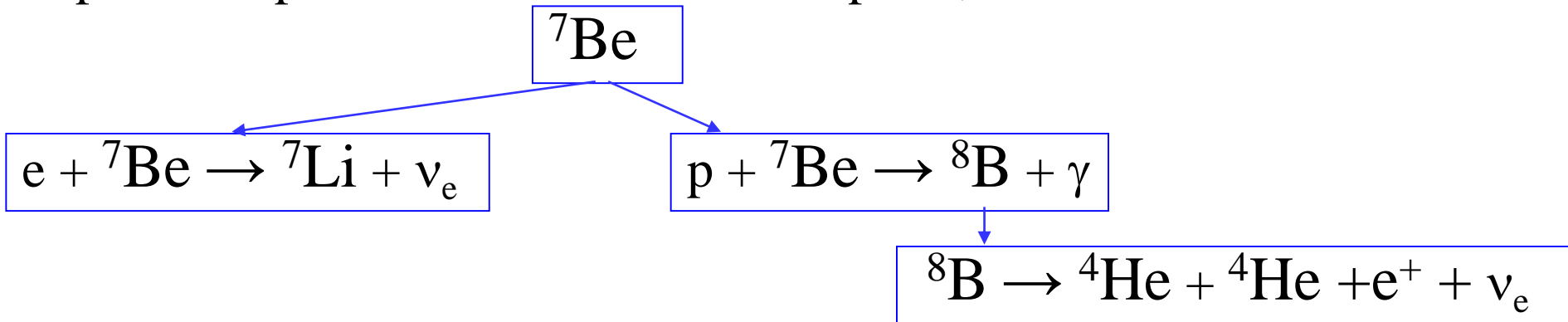

- $p$  capture is disfavoured with respect to  $e$  capture due to Coulomb repulsion, although the intrinsic strength of an e.m. process is larger than that of a weak process.
- Boron neutrinos have a continuous spectrum, extending to 14 MeV.
- Their intensity is about  $10^{-4}$  with respect to pp
- Predictions on B neutrinos are affected by larger errors, due to the several branching involved and to marked temperature dependence.

# Boron neutrinos

- Shape and production region are shown in the figures
- B- neutrinos are:
  - $10^{-4}$  in intensity with respect to pp
  - They are “high energy neutrinos”, in that their energy is higher than that of pp and of Be
  - They are produced in a more central region, where p capture on  ${}^7\text{Be}$  is more likely due to higher temperature.

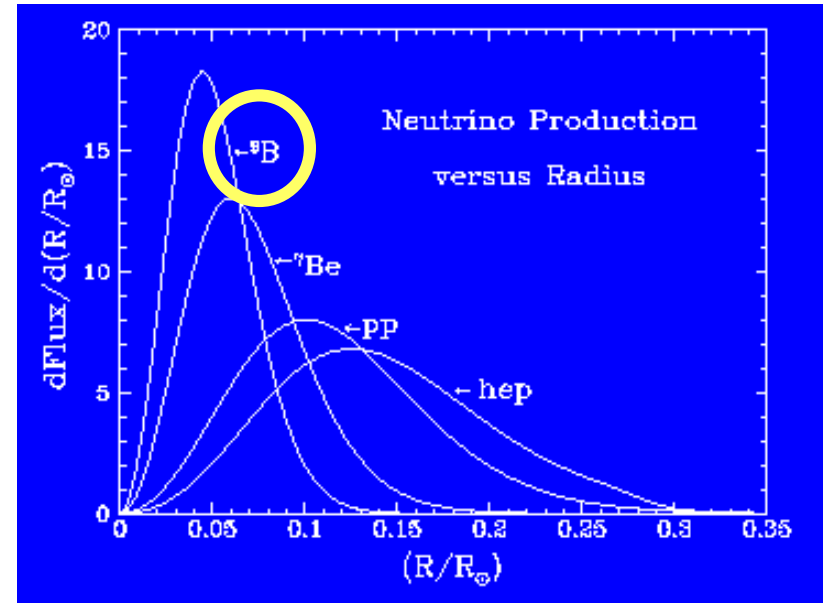
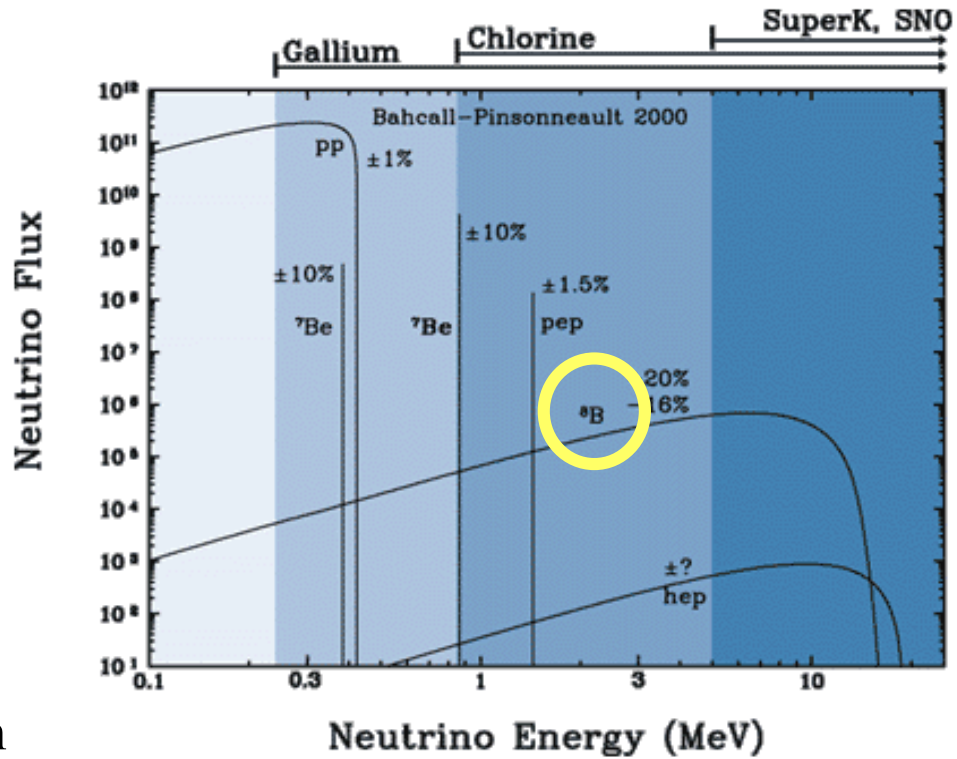

# Most studied solar neutrinos

|  | pp                            | ${}^7\text{Be}$                                     | ${}^8\text{B}$                                     |
|--|-------------------------------|---|--|
| name:  |                               |   |  |
| reaction:  | $p+p \rightarrow d+e^++\nu_e$ | ${}^7\text{Be}+e^- \rightarrow {}^7\text{Li}+\nu_e$ | ${}^8\text{B} \rightarrow {}^8\text{Be}+e^++\nu_e$ |
| energy:<br>[MeV]                                 | $\leq 0.42$                   | 0.861 (90%)<br>0.383 (10%)                          | $\leq 15$  |
| abundance:<br>[ $\text{cm}^{-2} \text{s}^{-1}$ ] | $5.96 \cdot 10^{10}$          | $4.82 \cdot 10^9$                                   | $5.15 \cdot 10^6$                                  |
| uncertainty:<br>( $1\sigma$ )                    | 1%                            | 10%   | 18%  |
| production<br>zone:                              | $0.1 R_\odot$                 | $0.06 R_\odot$                                      | $0.05 R_\odot$                                     |



# A group photo: energy space

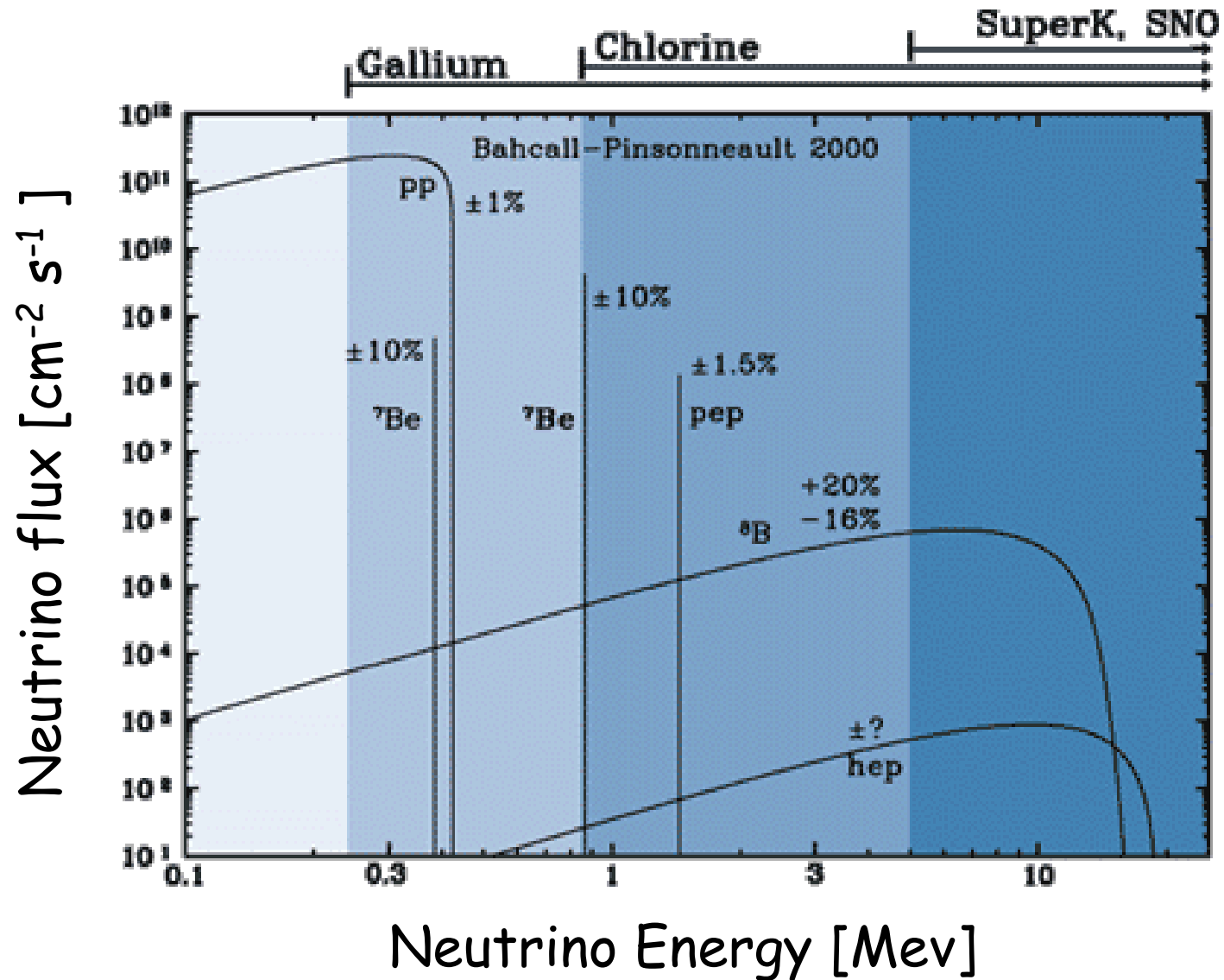

# A group photo : production region

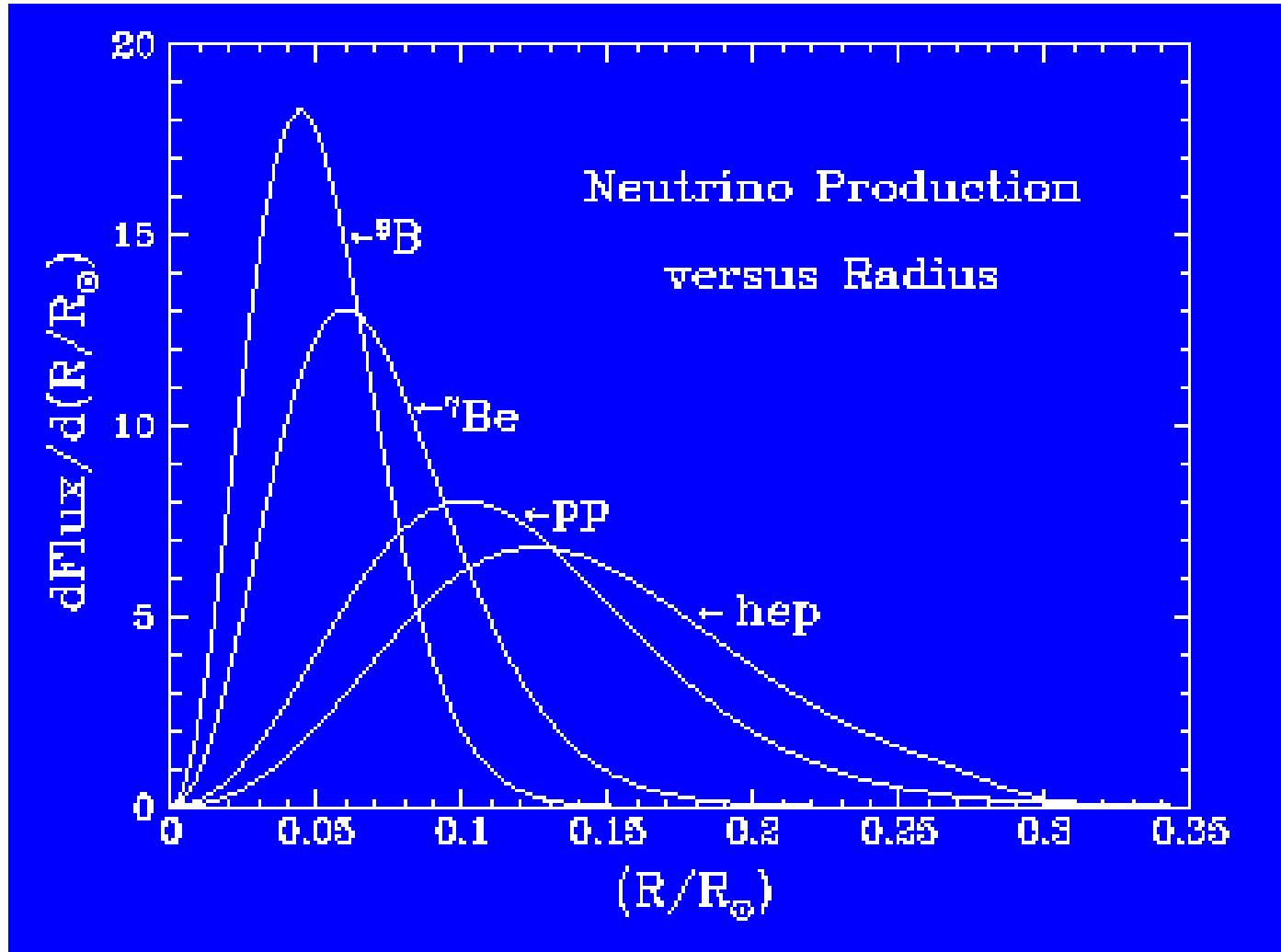

The fraction of neutrino produced inside the sun within  $dR$ <sup>18</sup>

## More neutrinos from the Sun: pep neutrinos , a variant of pp-I chain :

- Whenever a  $\beta^+$  decay is possible,  $(Z,A) \rightarrow (Z-1,A) + e^+ + \nu_e$  also Electron Capture is possible,  $e + (Z,A) \rightarrow (Z-1,A) + \nu_e$ , since  $Q(\text{EC}) = Q(\beta^+) + 2m_e$ , so if  $Q(\beta^+) > 0$  then also  $Q(\text{EC}) > 0$
- Thus  $d$  can be formed also through:

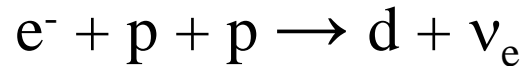

- This reaction is less likely ( $\approx 1\%$ ), than  $p + p \rightarrow d + e^+ + \nu_e$  since having three particles on a region with nuclear dimension is more difficult than two.
- The reaction produces monochromatic neutrinos, with

$$E = E_{\text{max}} + 2m_e = 1.4 \text{ MeV}$$

## pep neutrinos

- Shape and production region are shown in the figures
- neutrinos are:
  - the third source in intensity, after pp and Be
  - They are monochromatic
  - They are produced in the same region as pp.

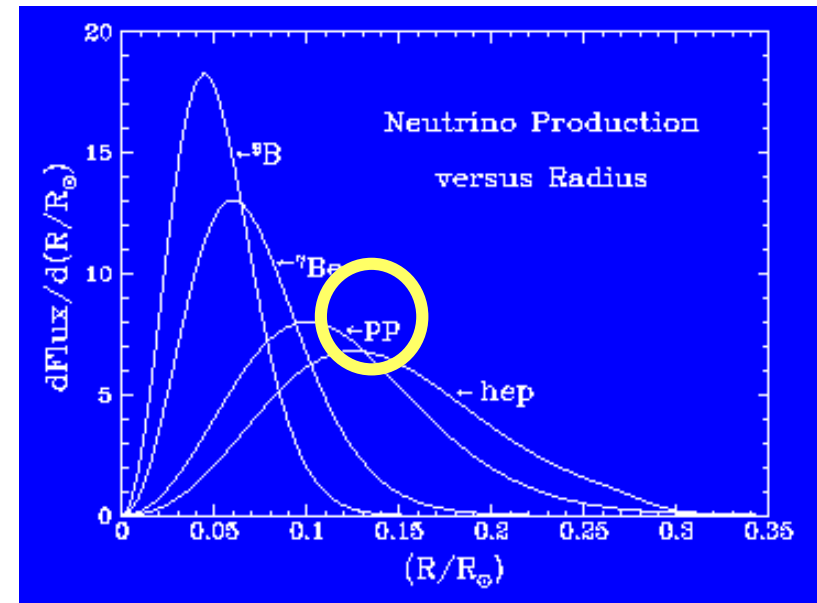
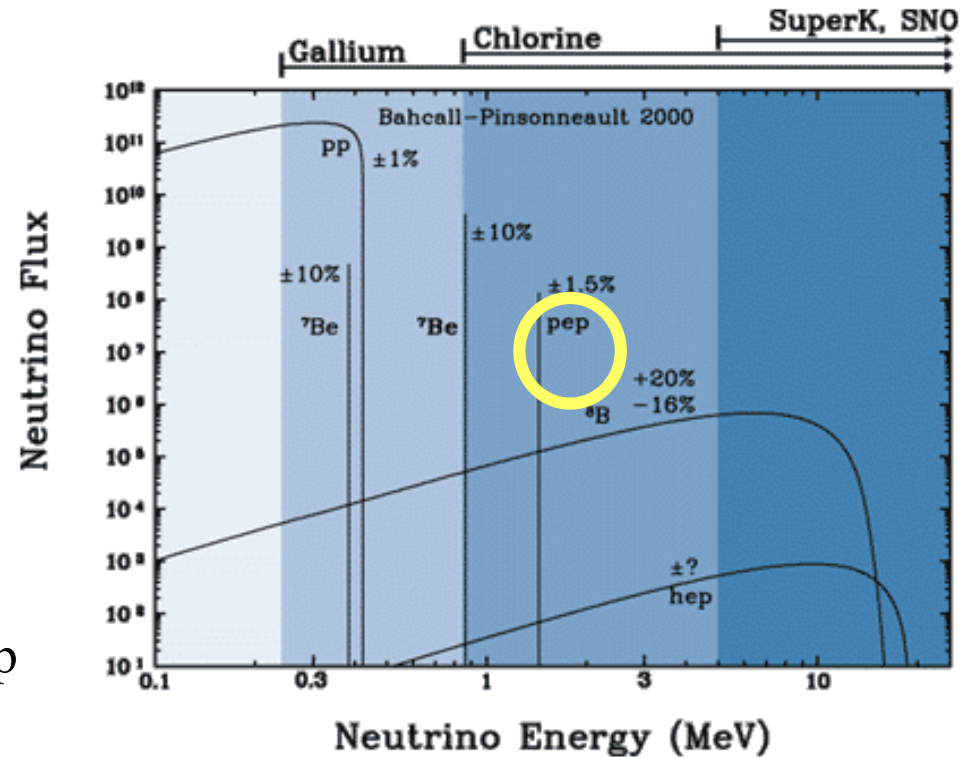

# More neutrinos from the Sun: $\nu$ from the CNO by-cycle

- In order to fuse  $4p \rightarrow 4\text{He}$ , one needs to transform 2 protons into two neutrons. This can be done with p-capture on a stable nucleus  $(Z,N)$ , the daughter nucleus being unstable due to  $\beta$  decay
 
$$p + (Z,N) \rightarrow \gamma + (Z+1,N) ;$$

$$(Z+1,N) \rightarrow (Z, N+1) + e^+ + \nu.$$
- The catalyst nuclei have to be relatively abundant in the Star and with  $Z$  as low as possible, so that Coulomb barrier can be overcome. C,N and O are suitable.
- The active branch of the CNO cycle is shown in figure\*. It is another way of getting;  $4p + 2e^- \rightarrow 4\text{He} + 2\nu_e$

\*)In fact one can have another cycle, to the right of the figure, involving  $^{17}\text{O}$ ,  $^{17}\text{F}$ ,  $^{16}\text{O}$  (exercise)

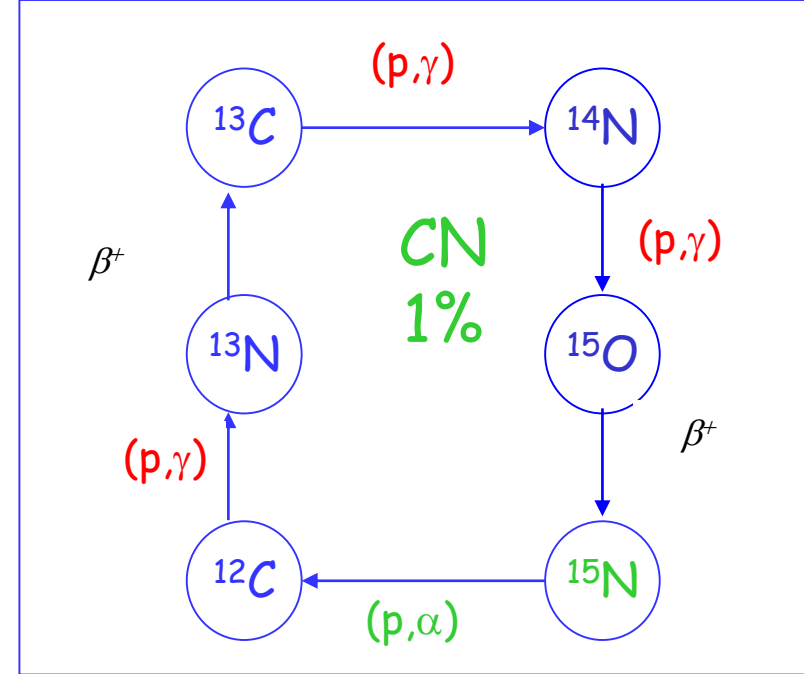

- Start, as an example, from  $^{12}\text{C}$ . By a series of p-capture and  $\beta^+$  decays one reaches  $^{15}\text{N}$ , which goes back to  $^{12}\text{C}$  with  $(p,\alpha)$  reaction.
- Note that C, N and O act as catalyst; they are transformed one into the other, but are not consumed.
- CNO cycle was initially advanced as the main source of the Sun, but soon it was realized that in the solar condition the pp chain is more efficient. Today, we believe that CNO provides 1% of solar energy.

# The equilibrium populations and the key reactions

- The branch of the CNO cycle involves four stable nuclei,  $^{12}\text{C}$ ,  $^{13}\text{C}$ ,  $^{14}\text{N}$  and  $^{15}\text{N}$ . The first three are transformed by proton capture into unstable nuclei, the  $\beta^+$  decaying  $^{13}\text{N}$  and  $^{15}\text{O}$ .
- If equilibrium holds, the populations are rearranged so that for each nucleus its creation rate equals the destruction rate.
- $n(^{12}\text{C})n(p)\langle\sigma v\rangle_{p^{12}\text{C}} = 1/\tau_{^{13}\text{N}} n(^{13}\text{N}) = \dots$   
 $\dots n(^{13}\text{C})n(p)\langle\sigma v\rangle_{p^{13}\text{C}}$
- The chain rate is dominated by the slowest reaction, i.e. with largest Z and weaker intensity. For this branch, this is clearly

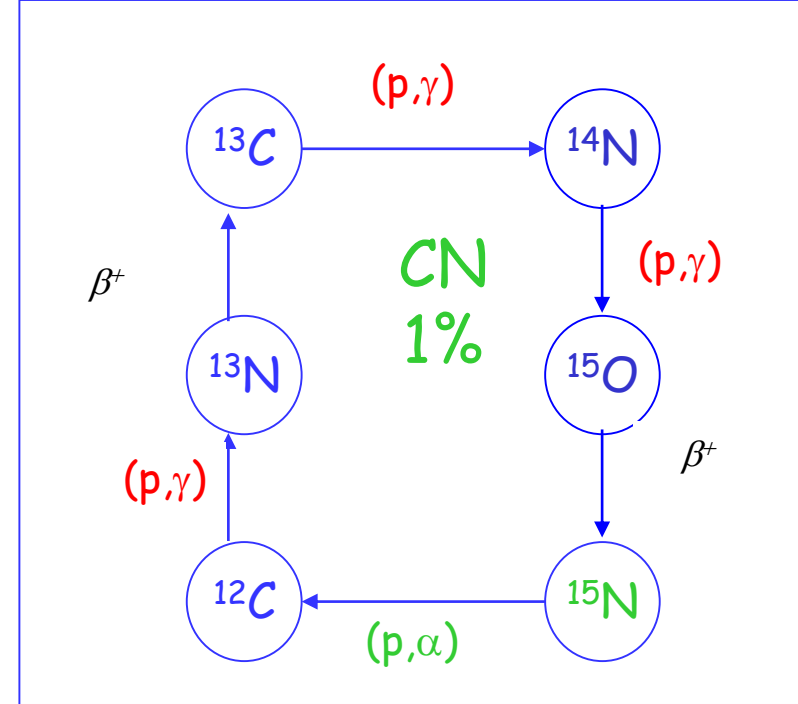

- Its determination fixes the chain rate.
- Note that due to the relatively large Z (in comparison with the pp chain) the rate is strongly dependent on temperature.
- Production of CNO neutrinos, like that of B, is concentrated near the solar centre.

# Summary of CNO-neutrinos

|   | N   | O   |
|---|---|---|
| name:   |   |   |
| reaction:   | $^{13}\text{N} \rightarrow ^{13}\text{C} + e^+ + \nu_e$ | $^{15}\text{O} \rightarrow ^{15}\text{N} + e^+ + \nu_e$ |
| spectrum:<br>[MeV]                                | $\leq 1.2$  | $\leq 1.7$  |
| abundance:<br>[cm <sup>-2</sup> s <sup>-1</sup> ] | $5.48 \cdot 10^8$                                       | $4.80 \cdot 10^8$                                       |
| uncertainty<br>(1 $\sigma$ )                      | 19%   | 22%   |
| production<br>zone:                               | 0.05 R <sub>o</sub>                                     | 0.05R   |

# The most studied solar neutrinos

- So far, B, Be and pp neutrinos are the ones which have been mainly studied
- B neutrinos are the "easiest" to detect. They provide information on the innermost part of the Sun
- Note that the dependence on the central temperature is  $\Phi_B = kT_c^{20}$ , thus they are very sensible thermometers of the solar interior. If  $\Phi_B$  is known to 10% then in principle\*  $T_c$  is measured with an accuracy
$$\Delta T_c / T_c = 1/20 \quad \Delta \Phi_B / \Phi_B = 0.5\%$$
- pp neutrinos are the bulk product of nuclear fusion in the Sun. Their measurement gives direct information on the energy production in the Sun
- Be neutrinos are the second source of neutrinos from the Sun, needed to fully account for the solar energetics and to understand the ppII/ppI branch
- \*In practice one needs to know with some accuracy the constant k



# Dependence on $T_c$

- By building different solar models, with varied inputs parameters (within their uncertainties) and by using a power law parametrization, one finds (approximately):

$$\Phi_B \sim T_c^{20}$$

$$\Phi_{Be} \sim T_c^{10}$$

$$\Phi_{pp} \sim T_c^{-0.7}$$

- B neutrinos has the strongest dependence, due both to  ${}^3\text{He}+{}^4\text{He}$  and (mainly) to  ${}^7\text{Be}+p$
- Be neutrinos strong depends on  $T_c$ , due to Gamow factor in  ${}^3\text{He}+{}^4\text{He}$
- For the conservation of total flux, pp neutrinos decrease with increasing  $T_c$

# Is the Sun fully powered by nuclear reactions?

- Are there additional energy sources beyond  $4p \rightarrow \text{He}$ ?
- Are there additional energy losses, beyond photons and neutrinos?
- One can determine the “nuclear luminosity” from measured neutrino fluxes,  $K_{\text{nuc}} = \Phi_{\text{tot}} Q/2$ , and compare with the observed luminosity  $K$ . Presently experiments give:

$$K_{\text{nuc}}/K = 1.4 (1 \pm 25\%) \quad (1\sigma)$$

- This means that, within 25%, the Sun is actually powered by  $4\text{H} \rightarrow \text{He}$  fusion...

# The Sun as a laboratory for astrophysics and fundamental physics

- The energy budget in the sun can also provide information on additional energy losses and/or particle emission
- One can find constraints (surprises, or discoveries) on:
  - Axion emission from the Sun
  - The physics of extra dimensions  
(through Kaluza-Klein axion emission)
  - Dark matter  
(if trapped in the Sun it could also change the solar temperature very near the center)

# Summary

- Solar neutrinos are becoming an important tool for studying the solar interior and fundamental physics.
- All this brings towards answering fundamental questions:
- Is the Sun fully powered by nuclear reactions?
- Is the Sun emitting something else, beyond photons and neutrinos?

# A 40 year long journey

- In 1963 J Bahcall and R Davis, based on ideas from Bruno Pontecorvo, started an exploration of the Sun by means of solar neutrinos.
- Their trip had a long detour, generating the “solar neutrino puzzle”
- All experiments, performed at Homestake, Kamioka, Gran Sasso and Baksan exploring different portions of the solar spectrum, presented a deficit of  $\nu_e$ .

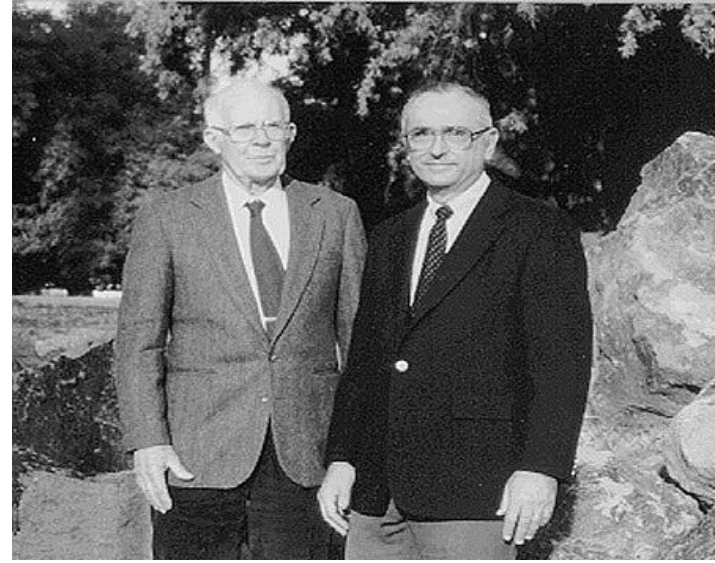

- Were all experiments wrong?
- Was the SSM wrong?
- Was nuclear physics wrong?
- Or did something happen to neutrinos during their trip from Sun to Earth?